

THIS DRAWING IS THE PROPERTY OF PRIMARY FLUID SYSTEMS INC. FROM WHICH A WRITTEN CONSENT FOR APPROVAL SHALL BE REQUIRED PRIOR TO COPYING.

REVISION HISTORY			
REV	DESCRIPTION	DATE	NAME
0	NEW DRAWING	---	---

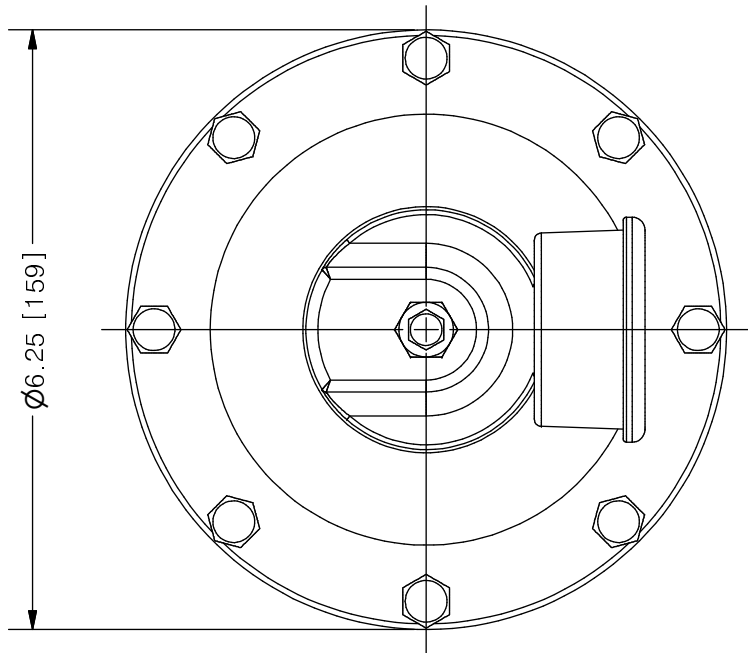

ACCU-PULSE®
APIIF PULSATION DAMPENER

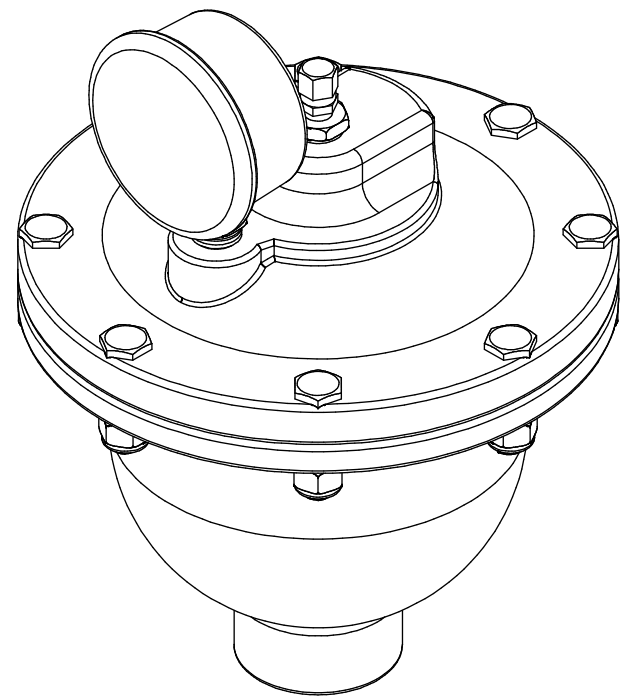

SCALE 1 : 2

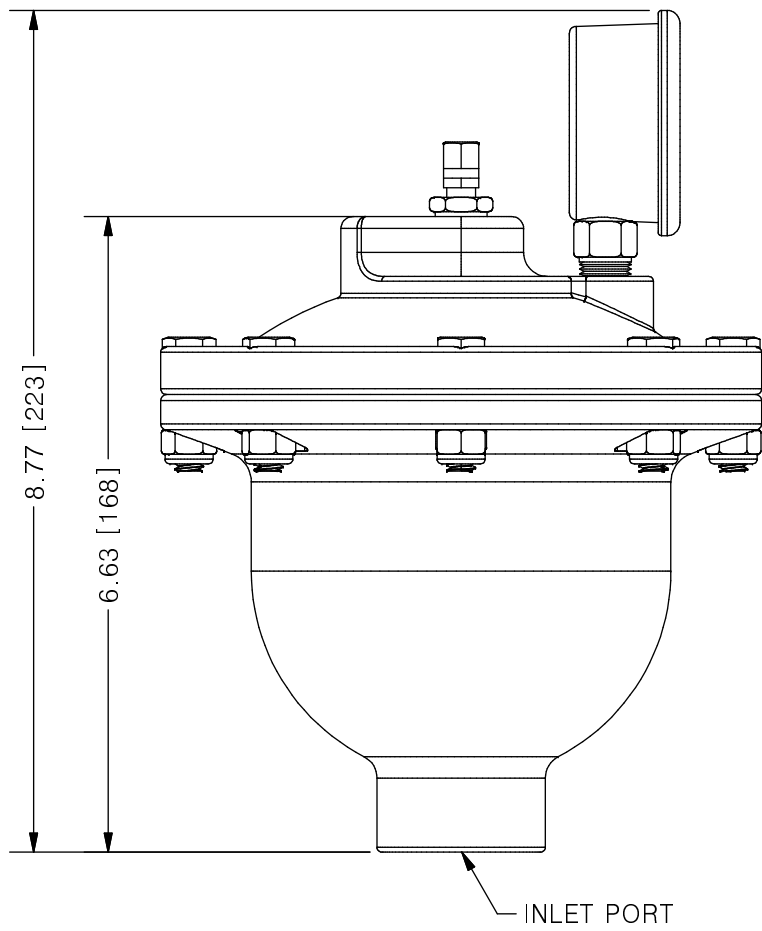

AVAILABLE BLADDER/BELLOW
EPDM
VITON
NEOPRENE
BUNA-N
HYPALON
PTFE

NO.	NAME	DESCRIPTION
1	MAX ALLOWABLE OPERATING PRESSURE	275PSI @ 70°F (21°C)
2	UNIT CAPACITY	36 CU IN
3	INLET PORT	3/4"
4	CONNECTION TYPE	NPT
5	BOTTOM HOUSING (WETTED)	316 S/S / C276 / ALLOY 20
6	BLADDER (WETTED)	SEE CHART ABOVE
7	TOP HOUSING	316 S/S
8	GAUGE CASE/BACKING	STAINLESS STEEL AND BRASS
9	TEE	ZINC PLATED STEEL
10	FILL VALVE	STAINLESS STEEL

PRIMARY FLUID SYSTEMS INC. 1050 COOKE BLVD, BURLINGTON, ONTARIO L7T 4A8	PROJECT: AP	SHT: 1 OF 1	DRAWN BY: NIKHIL G
	DATE DRAWN: 8/15/2016	SCALE: 1 : 2	UNITS: INCH[mm]
TITLE: ACCU-PULSE IIF PULSATION DAMPENER	MATERIAL: SEE CHART	DWG NO.: APIIF-ALLOY_R0	REV# 0
DWG NAME: APIIF	APPROVED BY:	CHECKED BY:	THIRD ANGLE PROJECTION
DWG TYPE: PLANAR VIEW 2D			DIMENSIONAL TOLERANCE 0.XX ± 0.25" 11 X 17 SHEET SIZE: B